

Article number: 03220040

Description: Fluro Rod End GILRSW 40-RR
Stainless steel complete with left-handed thread

Measures

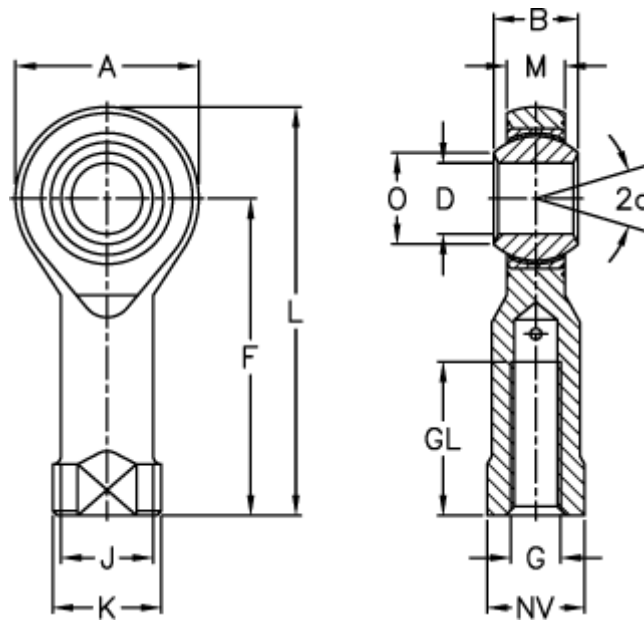

A	= 90	J	= 57	Weight (g) = 2270
a (degrees)	= 16	K	= 69	
B	= 49	L	= 187	
D	= 40	M	= 35	
Dynamic load C (kN)	= 286	NV	= 60	
F	= 142	O	= 44.2	
G	= M42x2	Permissible rpm	= 100	
GL	= 60	Static load C0 (kN)	= 235	